

Article number: 204350M16200D0TK  
 Description: E+G levelling foot  
 GN 43-50-M16-200-D0-TK  
 Note: TK With nut, Wrench flat at the bottom

## Measures

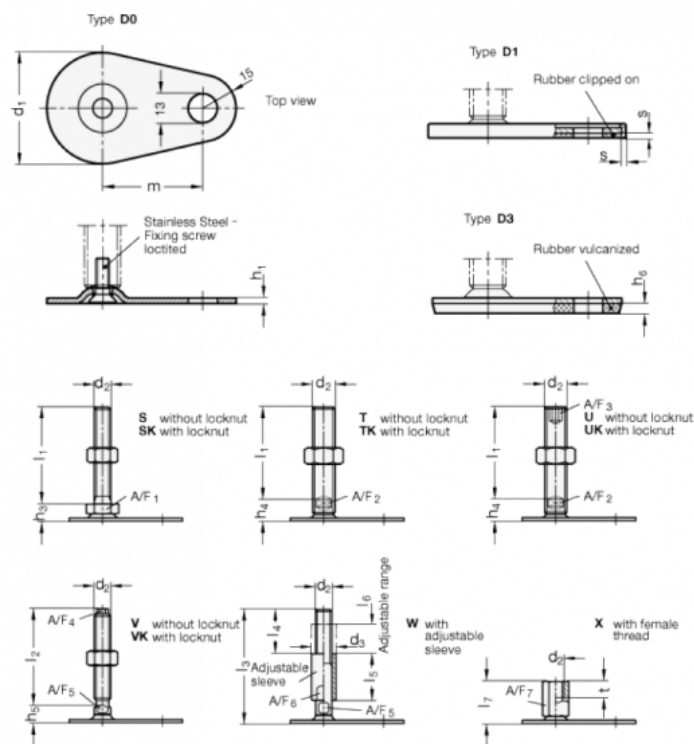

A/F2 = 12	s =
d1 = 50	
d2 = M16	
h1 = 2.5	
h4 = 17	
h6 =	
l1 = 200	
m = 45	